

Project processing example (step 1)

Project name: 27GL STORAGE BOX MOLD

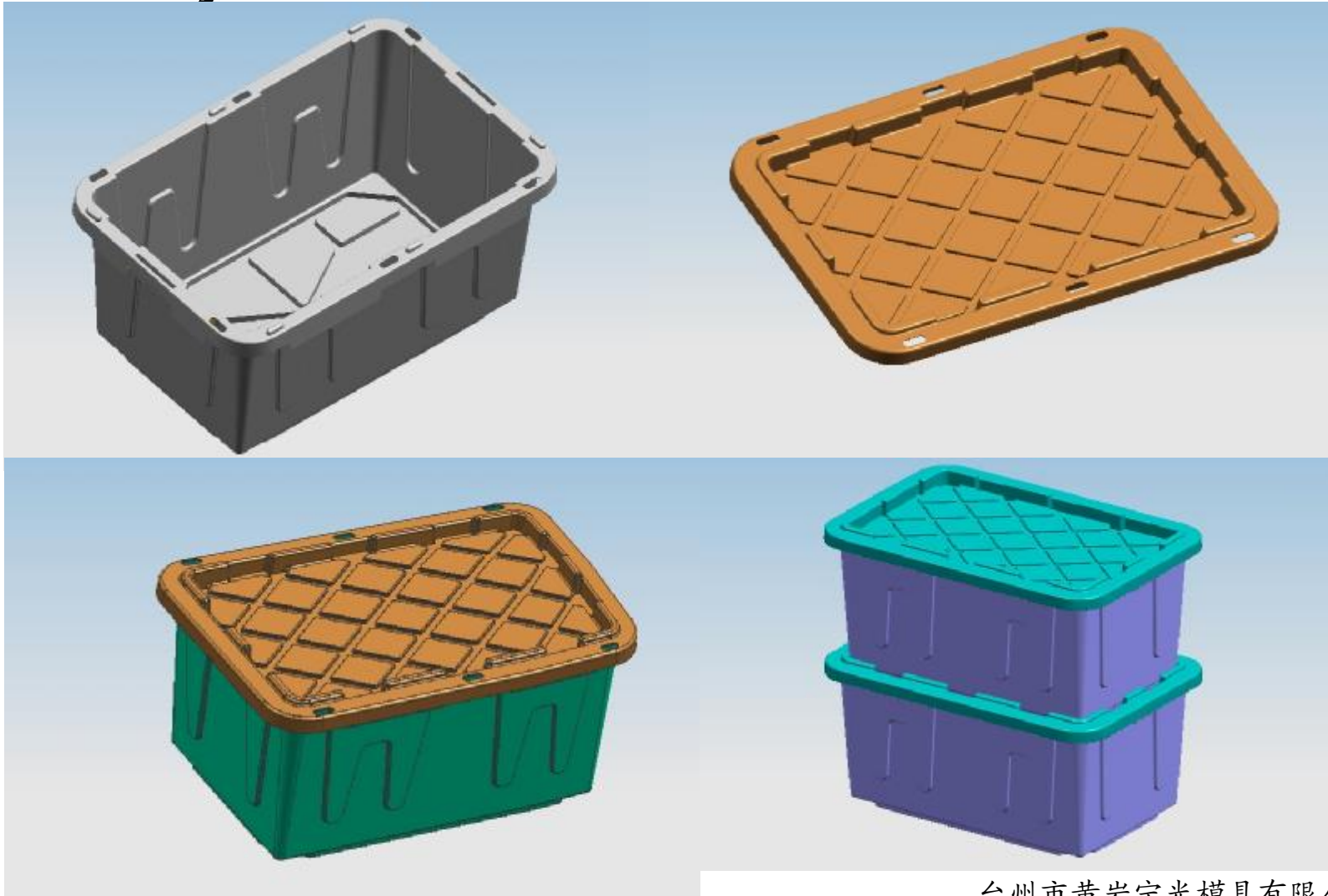



Project processing example (step 2)

✓ Mold flow analysis (27GL base)

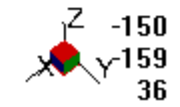
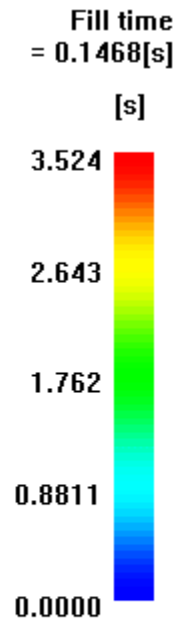
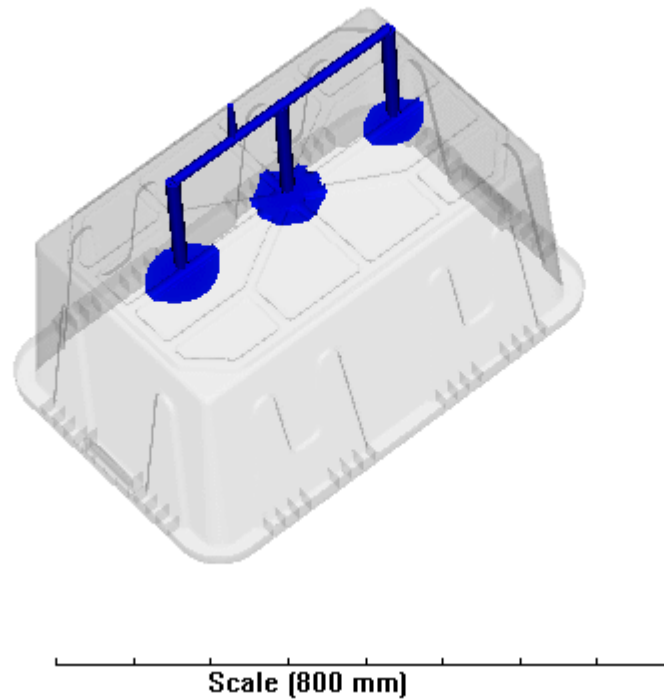



Project processing example (step 2)

✓ Mold flow analysis (27GL lid)

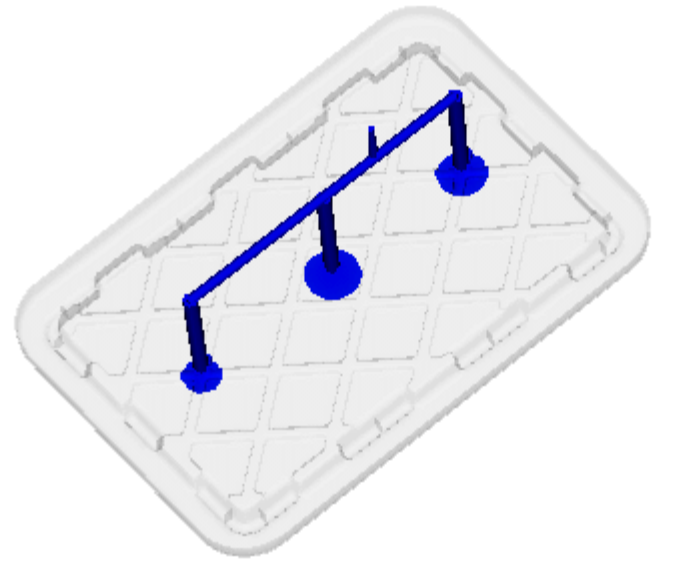

Fill time
= 0.1020[s]

[s]

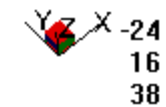

Scale (700 mm)

Project processing example (step 3)

Mold Picture

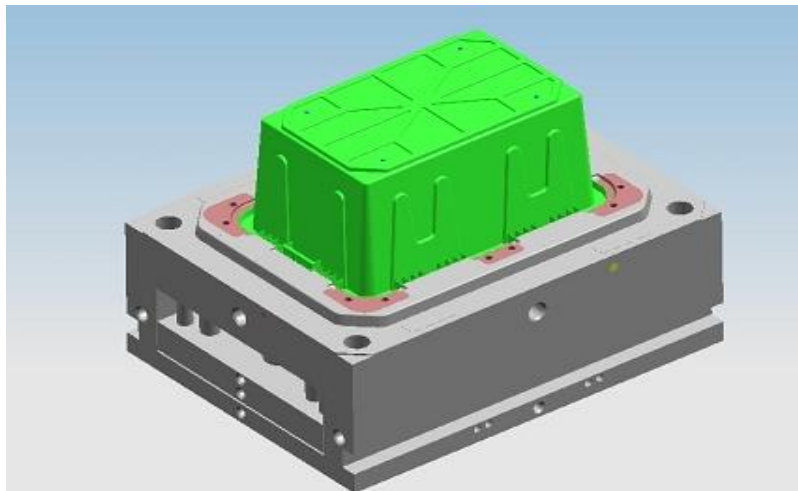
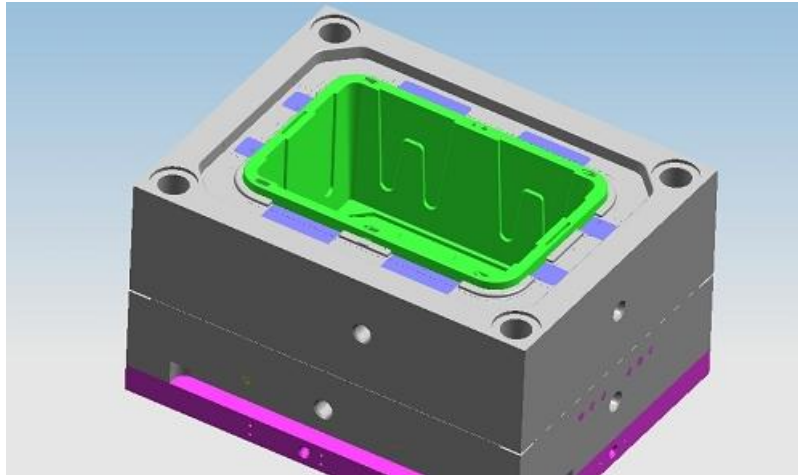

Project processing example (step 3)

✓ Sample picture

